

Hip Assistance Muscle Suit[®] Instruction Manual (Every Model)

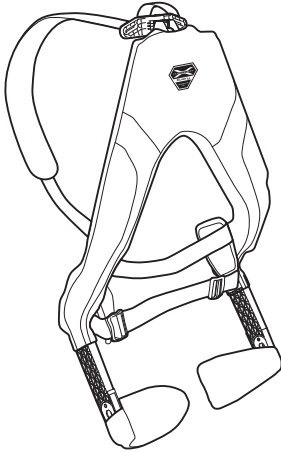

Contents

Introduction

About this product	P.1
Part names	P.2
Safety precautions	P.3
Check before wearing	P.3

How to use the Muscle Suit

Putting the suit on (for use mainly in a standing posture)	P.4
Putting the suit on (for use mainly in a crouching posture)	P.5
Filling the muscles with air	P.6
Working	P.7
After finishing	P.8
Inspection locations	P.8
Inspection details	P.9
How to remove/attach the outer covers and shoulder straps	P.10

Others

FAQ	P.12
Consumable parts and replacement	P.13
Troubleshooting guide	P.14
Specifications and package contents	P.15
Repair and after-sales service	P.16
Disposal	P.16

About this product

Objective This product is a wearable movement-assistance device that mainly acts as hip support while the wearer is maintaining a forward bent posture and lifting objects or people during nursing care or farming work.

Product composition and principles of operation

The back frame rotates around a rotational axis. One end of the artificial muscles is fixed to the top of the back frame, and the other end is attached to a wire. The other end of the wire is fixed to a pulley that is attached to the rotational axis of the thigh frame.

The following are the principles of operation:

When the pressure increases inside the artificial muscles, they contract to pull on the wires attached to the thigh frame and cause the back frame to rotate around the rotational axis as shown in ①, straightening the upper body. In response, the thigh frame is rotated in the direction shown in ② and the thigh pads suppress that rotational movement. It can be used in any position at any leg angle.

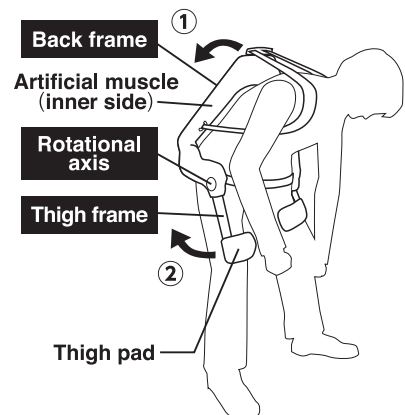

About the Every model of the Muscle Suit

The artificial muscles can be filled with air in advance with a hand pump for immediate use. The suit requires no batteries, compressors, or connections to external hoses for air supply, so the range of movement is unrestricted. The Every model is both lighter and thinner than the Edge model.

Part names

Shoulder straps

Belts for carrying the product on both shoulders.

Buckle

Fixes the hip belt in place.

Hip belt

A hip belt (upper) and a buttock belt are in the back, while an adjustment belt and a buckled belt are in the front.

Hip belt pad

Thigh frames

Transmit the force from the artificial muscles to the thigh pads.

Adjustment belt

Used to adjust the length of the buttock belt.

Thigh pads

Pads that sustain the rotational force that arises at the thighs with the assistive force from the device. Covered by thigh pad covers.

Artificial muscles (inner side)

When the pressure increases inside the muscles, they contract, and an assistive force arises. There is one on the right and one on the left, for a total of two muscles.

Main body cover

Protects the main body from dirt. (It is not waterproof.)

Front

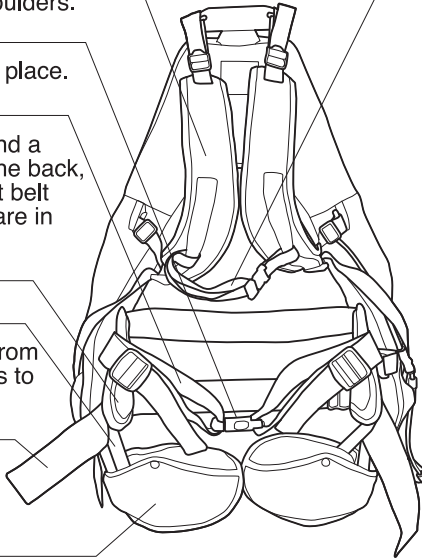

Chest strap

Locked at the chest position to keep the shoulder straps steady. The right and left shoulder straps are fixed in place with buckles. The chest strap can move up and down.

Pressure release valve

Pressed to release air from the artificial muscles. Air is released only while pressing this valve.

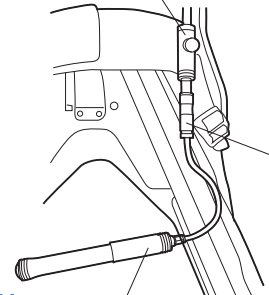

Air pump

Used to fill the artificial muscles with air.

Check valve

Prevents backward flow of air when operating the air pump.

Safety valve (inner side)

Bleeds air outside for safety if the pressure exceeds a certain level.

Hip belt (upper)

A belt on the hips for supporting the weight of the main body.

Buttock belt

Prevents this product from moving out of place. The belt has two adjusters at the back, one on the right and the other on the left, and the adjustment belt extends to the front from each of these. Pulling this belt brings the product into close contact with the buttocks.

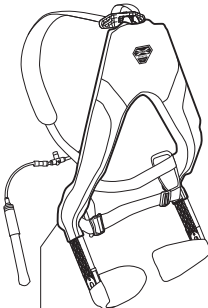
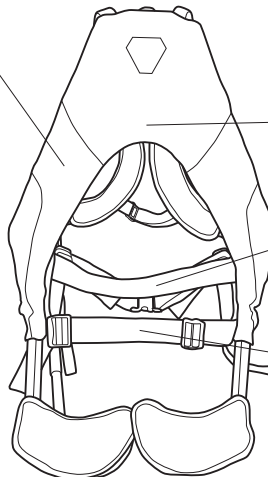

Back





Safety precautions

The precautions shown here indicate situations that could lead to serious accidents in certain circumstances. Be sure to follow every precaution for your safety.

About these symbols







 Warning	Indicates the possibility of death or serious injury to the user with incorrect use
 Caution	Indicates possible risk of injury to the user or property damage with incorrect use.

Meanings of symbols

	Indicates instructions that MUST be followed.
	Indicates GENERAL PROHIBITIONS .

Check before wearing

This section describes the points to check before putting on the product.

	Make sure that the outer cover is on the device before putting it on, or injury could result.
 Warning	 <p>This product is a wearable movement assistance device that specializes in reducing the burden on the hips when the wearer bends and stretches the hips to lift objects or people or maintaining a forward bent posture during nursing care or farming work. Do not use this product for any other purpose. This product is not a medical device. Do not use it for medical purposes. Also, it does not reduce lower-back pain. Never dismantle or modify the product, or an accident could result. Wear the product of a size that fits you, otherwise injury may occur. Do not try to use this product if you are feeling unwell, or your condition could deteriorate.</p>
	Be sure to inspect the product before use and ensure it is in the proper condition. Otherwise, damage to the product or an accident could occur.
 Caution	 <p>Do not leave anything in your pants or jacket pockets when putting on the suit. The objects could hinder operation, or the objects or the product itself could break.</p>

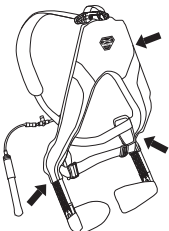
Items to check	Details to check
Outer cover	<p>The outer cover is attached correctly and is not dirty or damaged.</p> <p>If it is broken or torn, contact the reception for repairing a malfunction listed on page 16.</p> <div style="text-align: right;">  </div>

Putting the suit on (for use mainly in a standing posture)

This section describes how to put on the suit.

1 Step.1

Put on the Muscle Suit with both shoulder straps on the shoulders like when you put on a backpack.



2 Step.2

Lift the adjusters of the shoulder straps until the hip belt is at the height of your hips.



3 Step.3

Easten the hip belt and tighten the belt using the right and left adjusters.

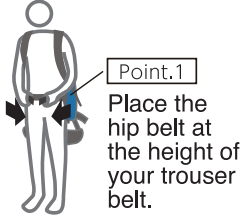

Point.1

Place the hip belt at the height of your trouser belt.

4 Step.4

Adjust the length of the buttock belt.

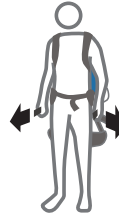

5 Step.5

Move the thigh pads to the front.



6 Step.6

Pump the air pump 30 to 45 times to fill the artificial muscles with air.

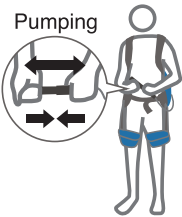

7 Step.7

Adjust the space between your back and the suit using the shoulder straps' adjusters.

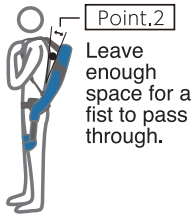

Point.2
Leave enough space for a fist to pass through.

8 Step.8

Fasten the right and left adjusters in front of the chest.



9 Step.9

Muscle Suit is now ready to assist with crouching and straightening the upper body.



Option Step

Adjust the assistive force by increasing or reducing the air volume.

Releasing air

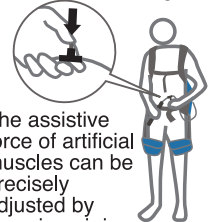

The assistive force of artificial muscles can be precisely adjusted by pumping air in or operating the release valve.

Tips for wearing the suit

If the product is improperly worn, it cannot produce its predetermined assistive force. Place the hip belt in the correct position (at the correct height). Also, do not over-tighten the shoulder straps.



Caution



- Before using the product for the first time, sufficiently practice putting it on in a safe place.
- Be sure to attach the outer cover to the main body.
- Leave adequate space around you to avoid hitting nearby people or things when putting it on.
- Make sure the outer cover is on the device when wearing it. Otherwise, injury could result.

Putting the suit on (for use mainly in a crouching posture)

This section describes how to put on the suit

1 Step.1 ~ 5 Step.5

Follow the steps for “Putting the suit on (for use mainly in a standing posture)” on page 4.

6 Step.6

Pump the air pump 30 to 45 times while in a crouching posture to fill the artificial muscles with air.

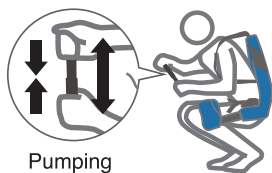

Pumping

7 Step.7

Adjust the space between your back and the suit using the shoulder straps' adjusters.

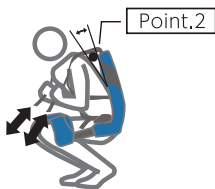

8 Step.8

Fasten the right and left adjusters in front of the chest.



Option Step

Adjust the assistive force by increasing or reducing the air volume.

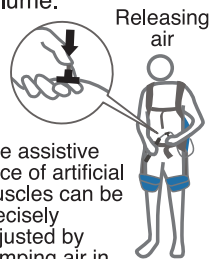

The assistive force of artificial muscles can be precisely adjusted by pumping air in or operating the release valve.

Tips for wearing shoulder straps

Leave space between your back and the main body.

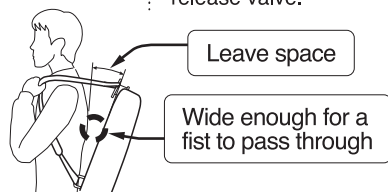

When working



Warning



- Do not use the product immediately after it has been dropped or bumped hard. Doing so could lead to an accident when wearing the suit. If it is warped or broken, contact the dealer or manufacturer.
- Do not use this product if it is in an abnormal condition, such as if it is making unusual noises or its movement is out of balance. An accident or damage to the product could result.
- Do not work in a place where there is no room behind your back. The product could damage objects behind or around you, or injure someone.
- Do not use the product in places that are very humid, dirty, or dusty or places that are subject to rain or foreign matter like iron filings, fine particles, or wood shavings. An accident or damage to the product could result.
- Do not use the product in places where there is corrosive gas, such as ammonia, acid, salt, or ozone gas. An accident or damage to the product could result.
- Do not perform any of the following actions while wearing the product. An accident could result.
 - Do not use the restroom or eat while wearing the product.
 - Do not go to unstable or slippery places while wearing the product. Also, do not put on the product in such places.
 - Do not operate forklifts or other vehicles while wearing the product.
 - Do not take a rest while wearing the product.

Filling the muscles with air

1. Fill the muscles with air

Hold the air pump with both hands and operate (pull and push in) the pump to fill the muscles with air.

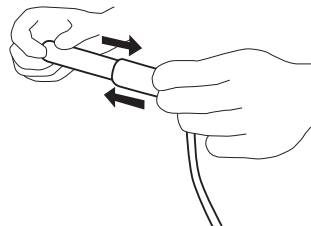

Recommended air volume

Generally, 30 to 45 pumps are needed when you start with empty muscles. Adjust the air volume to the type of work and your own muscle strength.

2. Adjust the air volume

Once you have put the Muscle Suit on, bend forward and check the strength of the assistive force before starting work. If the assistive force is too great, reduce the air volume (release air) to adjust it.

How to release air

Press the button on the release valve (red) repeatedly to gradually release the air.

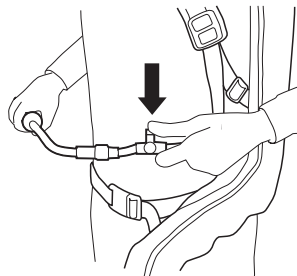

Adding more air

If you release too much air and want to add more, pump in more air.



Troubleshooting

- If the air pump is pumped about 70 times, the artificial muscles fill almost completely with air. With the muscles completely full, a whooshing sound may be heard from the safety valve on the back of the Muscle Suit as air leaks out when you bend forward with the Muscle Suit on. This is a safety mechanism and is meant to prevent overfilling with air; it is not a malfunction.
- The pressure of the filled air will slowly decrease over time. If you feel like the assistive force has become weak, add more air.

 Caution		Put the Muscle Suit on before filling the muscles with air. If the muscles are already filled with air when you put the Muscle Suit on, an assistive force will be produced in the thigh pads and make the suit difficult to put on. This could disrupt the balance of the body.
		Do not perform a pigeon-toed action with the muscles filled with too much air. An unintended action may occur, resulting in damage to the metal parts.

Working

To ensure you get the most from the product's functions and prevent injury, be sure you correctly understand how to use the product, and practice before use.

Actions being assisted

- Filling the artificial muscles with a certain volume of air causes this product to produce an assistive force that straightens the upper body with respect to the lower body when you straighten the body from a forward-bent posture or when you stand up from a crouching posture.
- Assistive force is likewise produced when you maintain a forward-bent posture.

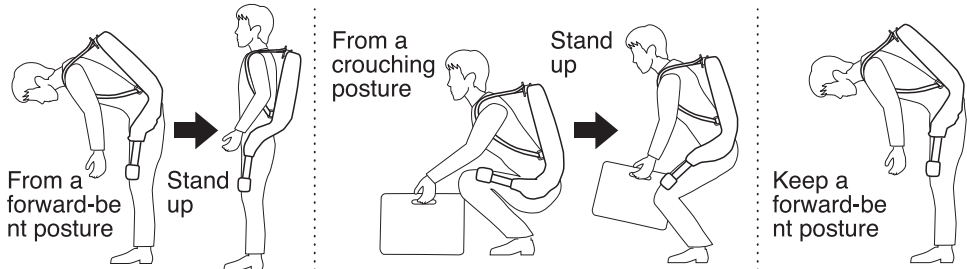

- The upper body straightens with the action of the artificial muscles, so lean against the Muscle Suit as much as possible.
- You can adjust the assistive force by altering the volume of the air pumped into the artificial muscles (see page 6).
- This product produces assistive force when you place a heavy object on the ground from an upright posture, such as when you lift an object.

		<ul style="list-style-type: none"> ● Practice before using the product according to the type of work, place, and surrounding environment and conditions. Otherwise, an accident could occur. ● When checking the product's operation, make sure the surroundings are safe. Otherwise, an accident could occur.
<p>Warning</p>		<ul style="list-style-type: none"> ● Do not lift objects that are heavier than what you can lift with your own arm strength and grip. Wearing this product does not increase your arm power or grip. Overstrain could result in an injury. ● Do not work in places where there are other people or objects or that are too small. Doing so could lead to an unexpected accident. ● This product can be used when you work near water; however, do not use it under water. ● Do not use the product if you cannot achieve good balance even after practice.
<p>Caution</p>		<p>In transfer assistance work, be careful not to catch the person being assisted on the buttock belt's adjustment belt. The belt loop may break.</p>

After finishing

After finishing the work, follow the steps below for storage.

How to store the product

- ① Press the button on the release valve (red) to release all the remaining air.
- ② Take off the product by following the steps for “Putting the suit on” on page 4 to page 5 in reverse order.
- ③ If the product gets dirty or wet, wipe it thoroughly with a dry cloth.
- ④ Store the product in a safe place.
Place it on a flat surface or on a hanger.

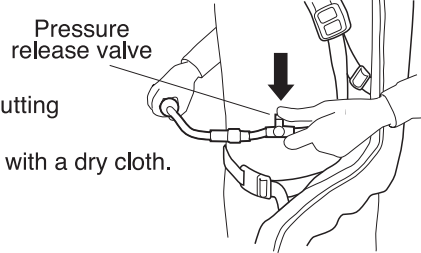

 Warning		Place the product on a flat surface or on a hanger when storing it, otherwise damage to this product or an accident could occur.
		<p>Follow the precautions below when storing the product, otherwise damage to this product or malfunction could result, leading to injury or accident the next time the product is used.</p> <ul style="list-style-type: none"> • Do not store it in places where it will be exposed to direct sunlight or where it may get wet. • Do not place objects on top of the product or sit on the product. • Do not place the product somewhere with a lot of people passing by, or in a hallway or pathway. • Do not store it in a place where it can be reached by small children.



Inspection locations

Be sure to inspect the product before use. This section also describes standard weekly and monthly inspections. You can change the frequency of inspections to suit your usage situation.

Item	Before use	Once a week	Once a month
Condition of the pressure release valve [Check the operation of the pressure release valve, referring to “2. Adjust the air volume” on page 6.]	○		
Attachment of the outer cover [Check to see if the outer cover is properly attached, zipped, and hooked up.]	○		
Condition of the air tube (See ① on page 9.)		○	
Dirt or tearing of the outer cover (See ② on page 9.)		○	
Warping of the frame (See ③ on page 9.)			○
Condition of the wire (See ④ on page 9.)			○
Condition of the wire (See ⑤ on page 9.)			○

Inspection details

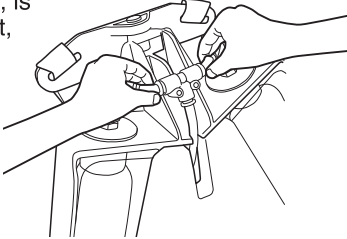
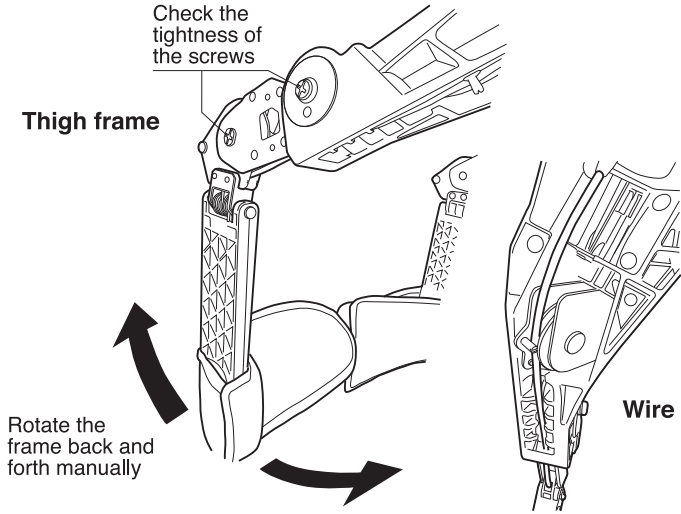
This section describes the pre-use inspection procedure.

Frequency	Inspection items
About once a week	<p>① Check if the air tube has come out, is deteriorated or bent, has holes in it, or is scratched, and press it with your hands to check if it works.</p> <p>② Check if the outer cover is dirty or torn. If it is dirty, remove it and wash it in water if necessary.</p> 
About once a month	<p>③ Look over the entire main body and all the components to check for bent or dented parts. If any parts are bent or dented, contact the reception for repairing a malfunction listed on page 16.</p> <p>④ Rotate the right and left thigh frames back and forth manually to check if there are any abnormalities in the wires or springs.</p> <p>⑤ Check the four screws of the right and left thigh frames (two for each thigh frame) to see if they are securely tightened.</p>  <div style="border: 1px solid black; padding: 5px; margin-top: 10px;">   <p>Be careful not to get your finger or anything else caught in the product.</p> </div>

How to remove / attach the outer covers and shoulder straps

The outer cover consists of the thigh pad covers (right and left), hip belt pads (right and left), and a main body cover, all of which can be removed for cleaning. Follow the explanation below to remove/attach.

How to remove the thigh pad covers

Undo the two hooks.

Be careful not to take off the cushion attached to the inside of the thigh pads when you attach and remove the thigh pad covers.

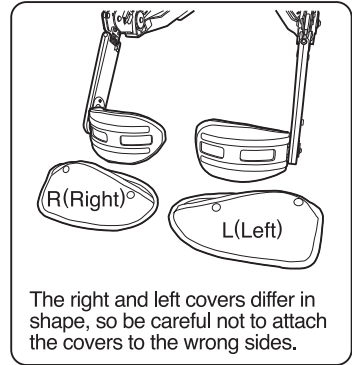
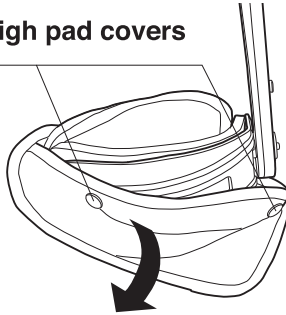

The right and left covers differ in shape, so be careful not to attach the covers to the wrong sides.

How to remove the hip belt pad

Undo the four hooks.

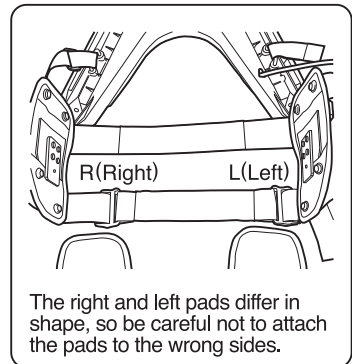
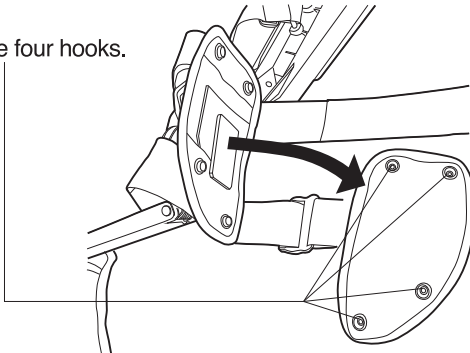

The right and left pads differ in shape, so be careful not to attach the pads to the wrong sides.

How to attach a shoulder strap that has been removed

Thread the shoulder strap through the upper adjuster.

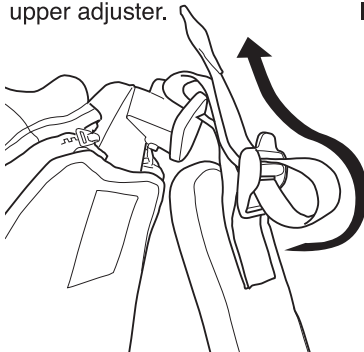

Thread the shoulder strap through the lower adjuster.

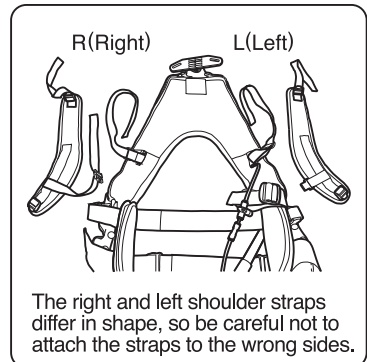
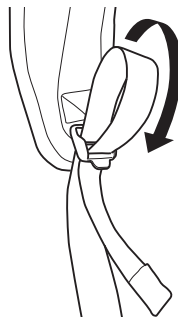

The right and left shoulder straps differ in shape, so be careful not to attach the straps to the wrong sides.

How to remove the main body cover

- ① Remove the pump from the holder.

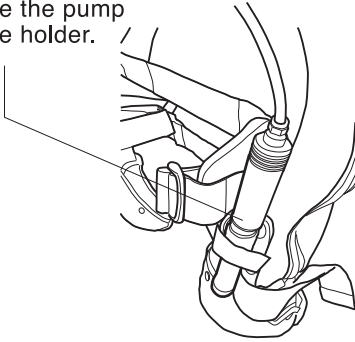

- ② Open the loop zipper.

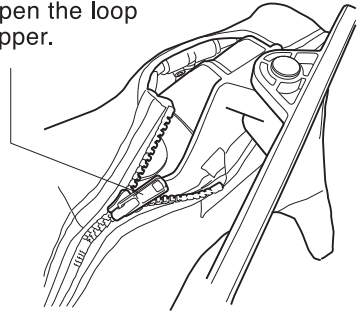

- ③ Completely open the zipper down to the thigh frames.

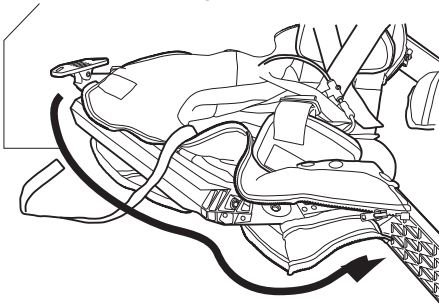

- ④ Undo the three hooks in front of each thigh frame and remove the main body cover.

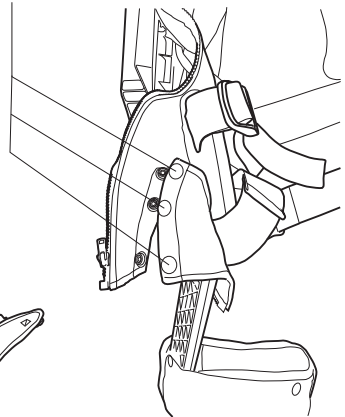

- ⑤ Allow the belt and tube pump to pass through a hole in the cover, and then remove the main body cover.

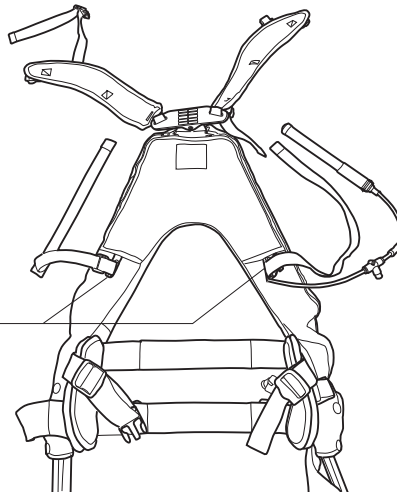

Caution



Be careful not to get your fingers caught in the product when you attach and remove the main body cover. Injury may result.

FAQ

● Weight

Q : It seems a little too heavy for women or weaker individuals.

A : This product is made so that its weight is carried on the hip belt. Check that the weight is being carried on the hip properly and that there is no load on the shoulders.

● Fit

Q : I am short and the thigh pads fall below my thighs.

A : The S-M size is recommended for shorter and/or thinner users.

Q : The thigh pads come off my thighs.

A : The S-M size is recommended for shorter and/or thinner users.

Q : Shouldn' t it fit more snugly on my back?

A : For the following reasons, the product is designed so that it is not snug against your back or shoulders:

- So that the weight is not placed on the shoulders.
- So that the product does not hit your back when you lean forward.

● Adjustments

Q : Can I wash the outer cover?

A : You can wash the cover in water, placing it in a laundry net. After washing it in water, let it dry completely before using it again.

Q : My body arches uncomfortably when lifting.

A : To adjust the angle of the arch of your body, loosen or lengthen the shoulder straps. This should relax the angle of the arch. Try putting on the suit again from the beginning, referring to **7** of “**Putting the suit on**” on page 4.If you still feel uncomfortable, stop using the suit.

Q : Are there any specific methods for inspecting the device?

A : See “**Inspection locations**” on page 8 and “**Inspection details**” on page 9.

Q : I can hear an unusual noise.

A : Apply a small amount of a silicone-based lubricant compatible with plastics. If you can still hear the noise, immediately stop using the product.

● Assistive force

Q : The burden on my hips is already small when doing work that requires lowering my body and using my leg strength. Is the Muscle Suit still useful for this type of work?

A : The Muscle Suit helps you straighten your upper body with respect to your lower body. When you do work that requires lowering your body, the suit can supplement your leg strength and help you stand up again.

Q : I want to further reduce the load from the weight when putting objects down.

A : Add more air pumped into the artificial muscles and try the work again. However, if the air pressure is too high, the safety valve will be triggered to release air from the artificial muscles. Also, you can increase the effectiveness by leaning against the Muscle Suit when putting objects down.

● Operation

Q : I cannot bend my knees or crouch down.

A : Release some air from the artificial muscles and try again. (See page 6)

● Putting it on and taking it off

Q : I will frequently have to take it off and put it on. How long will it take to remove and put on each time?

A : Simply put it on like a backpack, tighten the hip belt, and move the thigh pads to the front. With practice, it takes about 10 seconds by yourself.

Consumable parts and replacement

Replace the consumable parts for this product according to “Recommended replacement period” below. For replacement costs and procedures contact the reception for repairing a malfunction listed on page 16 (“Repair and after-sales service”).

Consumable part	Recommended replacement period	Details
Shoulder straps	When broken or very dirty	Buy a new one and replace it yourself.
Hip belt pad	When broken or very dirty	Buy a new one and replace it yourself.
Thigh pad cover	When broken or very dirty	Buy a new one and replace it yourself.
Main body cover	When broken or very dirty	Buy a new one and replace it yourself.
Air pump	When broken, or air does not come out when it is pressed	Buy a new one and replace it yourself.

Troubleshooting guide

The following table shows examples of malfunctions you may encounter when using the product. If you cannot solve problems by following the steps below, or if malfunctions other than those listed in the following table are observed, contact the reception for repairing a malfunction on the back page of this manual.

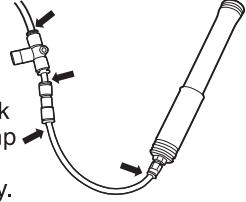
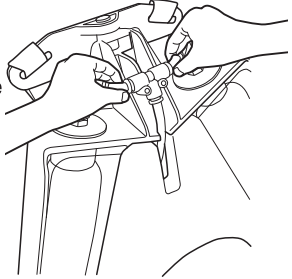
Problem	Cause	Solution
It does not fill with air.	The safety valve, check valve, or other hose connections may be loose.	<p>Push the hose connected to the safety valve, check valve, and air pump all the way in and connect it correctly.</p> 
Air leaks out immediately.		<p>Push the hose connection of the back shoulder part all the way in and connect it correctly.</p> 
It does not fill with air well.	The air pump may be broken.	Replace it with a new air pump.
I cannot bend forward.	There may be too much air in the muscles.	Press the button on the release valve (red) to gradually release the air and adjust the air volume. (See page 6)
I do not feel any assistive force.	There may be too little air in the muscles.	Attach the air pump and adjust the air volume. (See page 6)
	The thigh pads may not be touching your thighs.	Check if the thigh pads are in front of your thighs. (See page 4)
	If the position of the hip belt is incorrect, you may have difficulty feeling the assistive force.	Check the position of the hip belt. (See page 4)
	The Muscle Suit may not be the right size for you.	Use the correct size. There are two sizes of Muscle Suits. (See page 15)
	If the suit is not put on correctly, you may have difficulty feeling the assistive force.	Put the suit on correctly referring to “5 Putting the suit on” on page 4 to page 5.

Specifications and package contents

1. Specifications

Item	Specifications
Size	S-M size, M-L size
Main body dimensions Height × Width × Depth	805 mm × 465 mm × 170 mm (S-M size) 840 mm × 465 mm × 170 mm (M-L size)
Main body weigh	3.8 kg *Not including the cover
Driving force	Compressed air
Actuators	McKibben artificial muscles × 2
Compressed-air supply source	Hand pump
Air pressure to operate safety valve	0.5 MPa or higher
Assistive force	Max 25.5 kgf (100 Nm)
Assistance location	Hips
Temperature of usage environment	-30°C to 50°C
Applicable height (recommended)	S-M size: 150 to 165 cm M-L size: 160 to 185 cm
Dust-resistance, water-resistance	IP56

The specifications of this product are subject to change without notice in order to improve functioning.

2. Package contents

Open the box and make sure all of the following parts are inside.

If anything is missing or there are extra parts, please contact the dealer from which you purchased the product.

Name	Quantity	Details
Every Muscle Suit Main body	1	A hand pump, pressure-release valve (red), and check valve are connected to the air hose coming out of the main body.
Outer cover (attached to the main body)	1	Main body cover, thigh pad covers (right and left), hip belt pads (right and left)
Instruction manual (this document)	1	
Warranty	1	
Practical guide on how to wear and operate the product	1	

To ship the product, use the box in which the product was delivered when you purchased it. If the product is not well protected, it could be damaged by shocks during shipping.

Repair and after-sales service



To repair the product if it malfunctions, contact the dealer you purchased it from or the Reception for Muscle Suit Repair below. Inquire with the dealer for details about after-sales service

Repairs for malfunctions

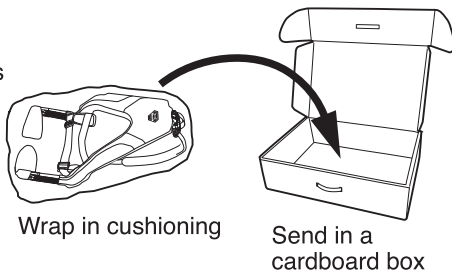
- ① Remove the air from the artificial muscles on the product.
- ② Wrap the product in cushioning material and place it in a cardboard box.
- ③ Follow the shipping instructions from the Reception for Muscle Suit Repair or the dealer.



Disposal

 Warning		If you wish to dispose of the product and/or its accessories, please do so in accordance with the regulations of your country and municipality.
--	---	---

Thank you for purchasing the Every Muscle Suit. Please read this instruction manual before using the product to ensure safe and proper use. Store the instruction manual somewhere you can read it whenever necessary. This is the instruction manual for the Every model Muscle Suit. The parts and associated devices differ depending on your usage environment and the options you have selected. Be sure to carefully read and learn the instruction manuals for parts and associated devices that are not explained in this instruction manual, and familiarize yourself with the methods for use to ensure your safety.

This instruction manual is copyright of Innophys Co., Ltd. Copying, reproducing, or reprinting all or part of this instruction manual without permission is prohibited. Note that the actual product may differ slightly from the illustrations in this instruction manual.



Instruction Manual for Every Muscle Suit®
MS08_Ver0.2

