

# ROUST-A-BOUT LIFTER SPECIFICATIONS

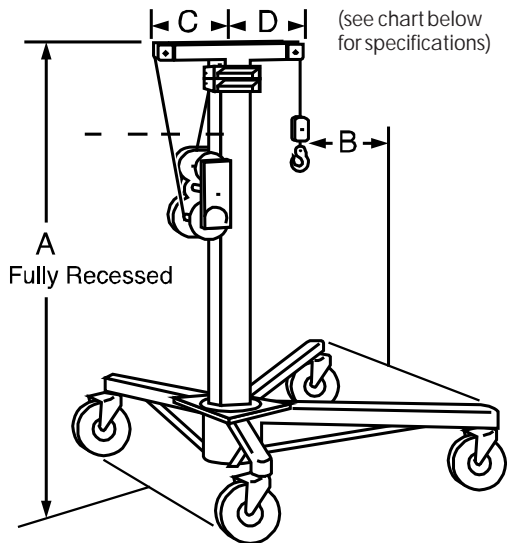

Mast and base sections separate quickly for ease of transportation and storage.



An ergonomic lifting trolley that allows a user to lift and place loads in tight locations - a task often impossible with other devices!

- ▶ Lifts 680 kg
- ▶ 4.6, 5.5 and 7.6 m foot heights
- ▶ Moves vertically and horizontally
- ▶ 2 Winches: operate load and mast elevation separately
- ▶ 4-Speed Load winches
- ▶ Infinite load height adjustment
- ▶ Ideal for job or shop
- ▶ Enables one man to perform as a crew – pays for itself in days!
- ▶ Lift and place loads in tight locations impossible for other lifts
- ▶ 200 mm castors permit full load to be positioned with ease
- ▶ Tee Head Extension available for wider loads up to 455 kg
- ▶ Eliminates the need for come alongs, scaffolds, monorails and swing booms

Part No.	Description	Weight		A		B		C/D		Base		Max Height	
		lb	kg	inch	cm	inch	cm	inch	cm	inch	cm		
780300	R-100 Roust-A-Bout 15' Top Height	330	150	79	200	20	50	12	30	32 x 40	80 x 100	15' 2-1/2"	4.6
780301	R-150 Roust-A-Bout 15' Top Height	336	152	79	200	20	50	12	30	40 x 40	100 x 100	15' 2-1/2"	4.6
780302	R-180 Roust-A-Bout 18' Top Height	403	183	126	320	25	63	14.5	36	50 x 50	125 x 125	17' 11-5/8"	5.5
780303	R-250 Roust-A-Bout 25' Top Height	493	224	119	302	30	75	17.5	44	60 x 60	150 x 150	25' 3/8"	7.6

# The Roust-A-Bout Tackles the Tough Jobs:

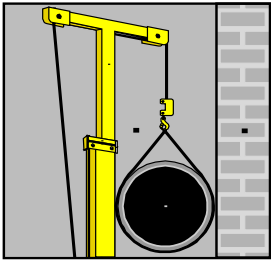

The Roust-A-Bout operates in tight areas that are inaccessible for other lifts.

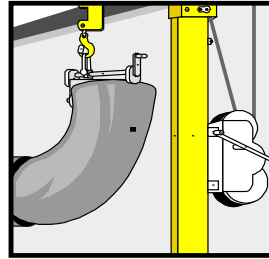

Used in combination with Adjust-A-Fit, the Roust-A-Bout can move awkward objects for easy placement.

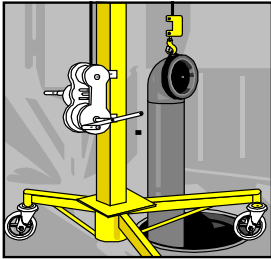

Loads can be lowered below floor level with the Roust-A-Bout's unique design.

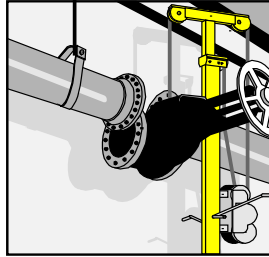

One man can position objects weighing 680 kg with infinite accuracy - up to 25 feet above!

Available in optional galvanised finish!

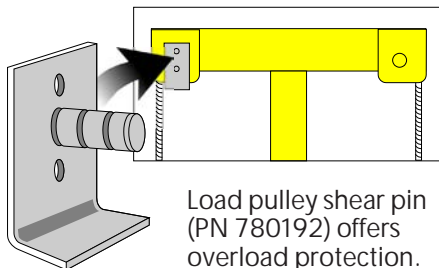

Load pulley shear pin (PN 780192) offers overload protection. Each Roust-A-Bout comes with a spare for quick, in-field resetting.

## Two Winch System

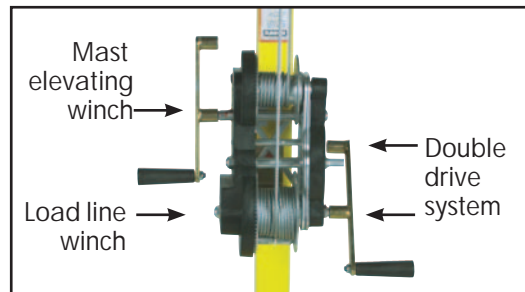

## Tee-Head Extension Bar

Lift wider loads with the Sumner Roust-A-Bout!

▀ Takes only minutes to attach or detach

▀ Expands the Roust-A-Bout for handling bulky loads up to 455 kg

Part No.	Description	Weight		A		B		C	
		lb	kg	inch	cm	inch	cm	inch	cm
781060	R-100/150 Tee-Head Extention Bar	21	9.5	22	55	43	108	48	120
781061	R-180 Tee-Head Extention Bar	24	11.0	29	73	58	145	63	158
781062	R-250 Tee-Head Extention Bar	33	15.0	37	93	73	183	68	173

Caution: Load center is moved to only 10 cm back of front castors, decreasing stability. Use carefully and only on bulky loads up to 455 kg.

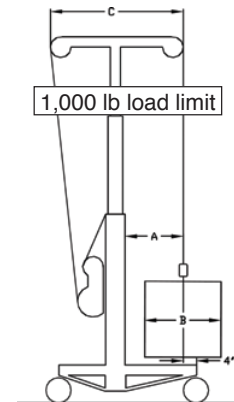

Australia Wide Sales & Service

sales@materialshandling.com.au | www.materialshandling.com.au | 1300 25 84 07

**MATERIALS**  
Handling *Working with ease.*