

125mm Rotacasters

Product Catalogue









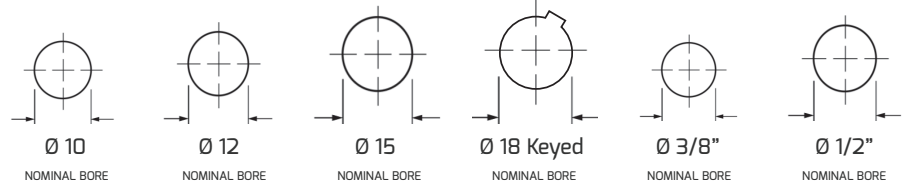













Australia Wide Sales & Service

sales@materialshandling.com.au | www.materialshandling.com.au | 1300 25 84 07

MATERIALS
Handling PTY LTD *Working with ease.*



WHEELS	BUSH/BEARING	PART NUMBER					
 <p>R2 Durometer (Hardness) 85A Capacity (Lateral/Static) 57/115 Kg</p>	 Plain	--	--	--	R2-1258-8518	--	--
	 Nylon	--	R2-1258-85/N12	--	--	--	R2-1258-85/N13
	 Shielded	R2-1258-85/Z10	--	--	--	R2-1258-85/Z09	--
	 Sealed	R2-1258-85/S10	R2-1258-85/S12	R2-1258-85/S15	--	--	R2-1258-85/S13
 <p>R2 Durometer (Hardness) 95A Capacity (Lateral/Static) 68/125 Kg</p>	 Plain	--	--	--	R2-1258-9518	--	--
	 Nylon	--	R2-1258-95/N12	--	--	--	R2-1258-95/N13
	 Shielded	R2-1258-95/Z10	--	--	--	R2-1258-95/Z09	--
	 Sealed	R2-1258-95/S10	R2-1258-95/S12	R2-1258-95/S15	--	--	R2-1258-95/S13
 <p>R3 Durometer (Hardness) 85A Capacity (Lateral/Static) 80/130 Kg</p>	 Plain	--	--	--	R3-1258-8518	--	--
	 Nylon	--	R3-1258-85/N12	--	--	--	R3-1258-85/N13
	 Shielded	R3-1258-85/Z10	--	--	--	R3-1258-85/Z09	--
	 Sealed	R3-1258-85/S10	R3-1258-85/S12	R3-1258-85/S15	--	--	R3-1258-85/S13
 <p>R3 Durometer (Hardness) 95A Capacity (Lateral/Static) 80/160 Kg</p>	 Plain	--	--	--	R3-1258-9518	--	--
	 Nylon	--	R3-1258-95/N12	--	--	--	R3-1258-95/N13
	 Shielded	R3-1258-95/Z10	--	--	--	R3-1258-95/Z09	--
	 Sealed	R3-1258-95/S10	R3-1258-95/S12	R3-1258-95/S15	--	--	R3-1258-95/S13

Load Capacity Notes:

■ **Lateral Load Capacity** refers to the maximum load capacity of each wheel to travel directly sideways without radial head contact. ■ **The Dynamic Load Capacity** (while in motion) ranges between the maximum **Static** and the **Lateral Load Capacity** and varies proportionally to speed of the wheel travelling in its primary direction.

Wheel Dimensions (in mm)

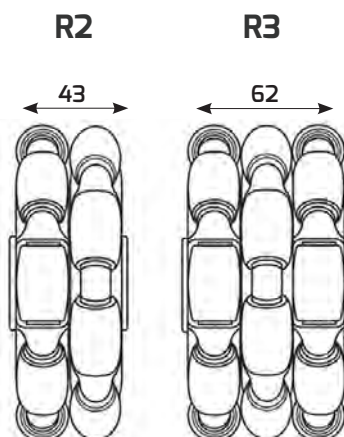
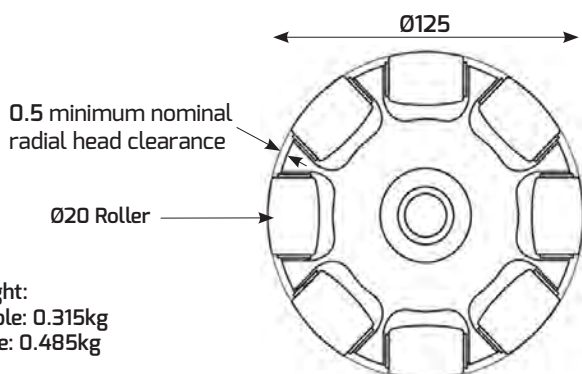

Conversion

Metric	Imperial
3.2mm	1/8"
6.35mm	1/4"
8.00mm	5/16"
9.53mm	3/8"
11.1mm	7/16"
12.7mm	1/2"
15.88mm	5/8"
25.4mm	1"

Rotacaster Wheels products are patented.

125mm Rotacaster Single Mount

STEEL FORKS (ZINC PLATED)

	R2 Formed	R3 Welded	R4 Formed
DUROMETER	PART NUMBER (Lateral / Static Load Capacity)	PART NUMBER (Lateral / Static Load Capacity)	PART NUMBER (Lateral / Static Load Capacity)
85A	R2-1258-85/MF 68/115 Kg	R3-1258-85/MW 80/130 Kg	R4-1258-85/MF 120/200 Kg
95A	R2-1258-95/MF 68/125 Kg	R3-1258-95/MW 80/160 Kg	R4-1258-95/MF 120/220 Kg

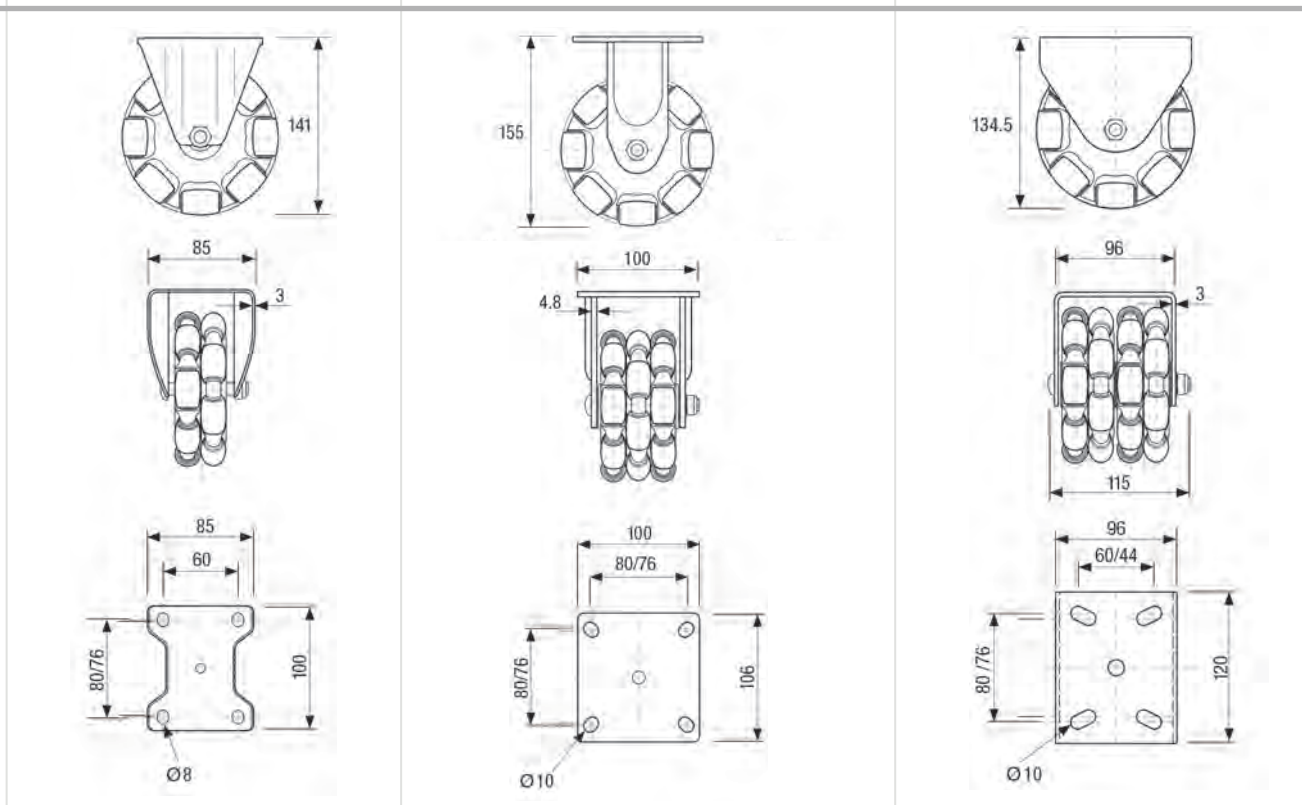

Load Capacity Notes:

■ **Lateral Load Capacity** refers to the maximum load capacity of each wheel to travel directly sideways without radial head contact. ■ **The Dynamic Load Capacity** (while in motion) ranges between the maximum **Static** and the **Lateral Load Capacity** and varies proportionally to speed of the wheel travelling in its primary direction.

FLOOR LOCKS

Friction Pad Floor Lock 11-9003

Mounting height: 132mm
Load capacity: 770kg

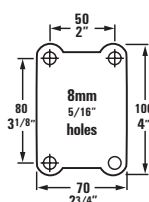

Lift Up Floor Lock 11-9002

Mounting height: 142mm
Load capacity: 200kg

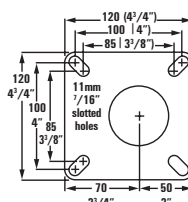

Rotacaster Wheels products are patented.

125mm Rotacaster Multi Mounts



MULTI MOUNTS (ZINC PLATED MILD STEEL)



Multi Mount 2 x RC Wheels



Multi Mount 3 x RC Wheels

WHEELS		PART NUMBER (Static Capacity)	PART NUMBER (Static Capacity)
R3	 85A	R3-1258-85/MM2 (135Kg)	R3-1258-85/MM3 (200Kg)
	95A	R3-1258-95/MM2 (165Kg)	R3-1258-95/MM3 (240Kg)
R4*	 85A	R4-1258-85/MM2 (220Kg)	R4-1258-85/MM3 (300Kg)
	95A	R4-1258-95/MM2 (250Kg)	R4-1258-95/MM3 (340Kg)

Stainless steel multi mounts are available on request. *R4 Rotacaster Wheels are composed by 2 x R2 Rotacaster Wheels and need to be fixed within a mount or channel.

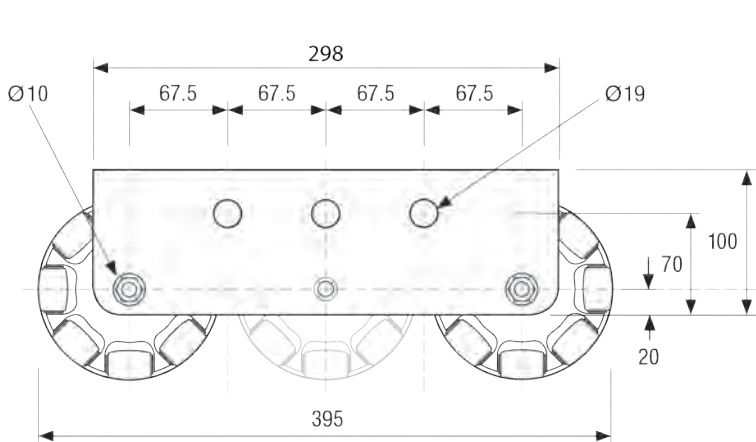

Note: measurements are in mm

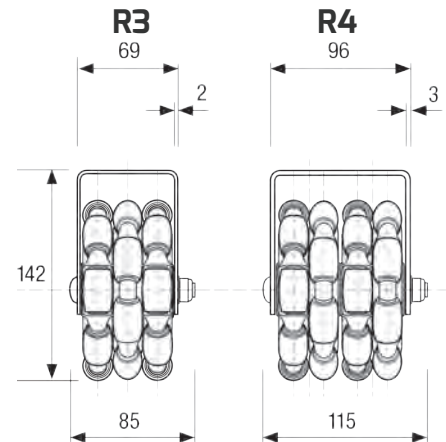

ROTASKATES (Rotaskates are assembled with 2 x 600mm steel bars)

R3 X 2 SKATE
PART NUMBER: M-5322-02/R3

R4 X 2 SKATE
PART NUMBER: M-5323-02/R4



R3 X 3 SKATE
PART NUMBER: M-5322-03/R3

R4 X 3 SKATE
PART NUMBER: M-5323-03/R4



OTHER MULTI MOUNT OPTIONS
(FOR DIFFERENT LOAD REQUIREMENTS)



* Bars in different lengths available

Australia Wide Sales & Service

sales@materialshandling.com.au | www.materialshandling.com.au | 1300 25 84 07

MATERIALS
Handling PTY LTD *Working with ease.*